

Powered by



GP 12400 ▶ 12V 40Ah

GP 12400 is a general purpose battery up to 5 years in standby service or more than 260 cycles at 100% discharge in cycle service. As with all CSB batteries, all are rechargeable, highly efficient, leak proof and maintenance free.



► Specification

Cells Per Unit	6
Voltage Per Unit	12
Capacity	40A h @ 20hr-rate to 1.75V per cell @25°C (77°F)
Weight	Approx. 12.63 kg(27.84 lbs)
Maximum Discharge Current	400A(5sec)
Internal Resistance	Approx. 8.1mΩ
Operating Temperature Range	Discharge: -15°C~50°C(5°F~122°F) Charge: -15°C~40°C(5°F~104°F) Storage:-15°C~40°C(5°F~104°F)
Nominal Operating Temperature Range	25°C±3°C (77°F±5°F)
Float Charging Voltage	13.5 to 13.8 VDC/unit Average at 25°C (77°F)
Recommended Maximum Charging Current Limit	12A
Equalization and Cycle Service	14.4 to 15.0 VDC/unit Average at 25°C (77°F)
Self Discharge	CSB Batteries can be stored for more than 6 months at 25°C(77°F). Please charge batteries before using. For higher temperatures the time interval will be shorter.
Terminal	B2-L terminal or Recessed type to accept M5 bolt
Container Material	ABS(UL 94-HB) & Flammability resistance of (UL 94-V0) can be available upon request.



MH14533(N)



No :041005117



ISO 14001
NO.UM 1-12-0045

CSB-manufactured VRLA batteries are UL-recognized components under UL1989.

CSB is also certified by ISO 9001 and ISO 14001.

► Dimensions :

Unit: mm (inch)	Overall Height (H)	Container height (h)	Length (L)	Width (W)
	170±2 (6.69±0.08)	168.5±2 (6.63±0.08)	197±2 (7.76±0.08)	165±2 (6.5±0.08)

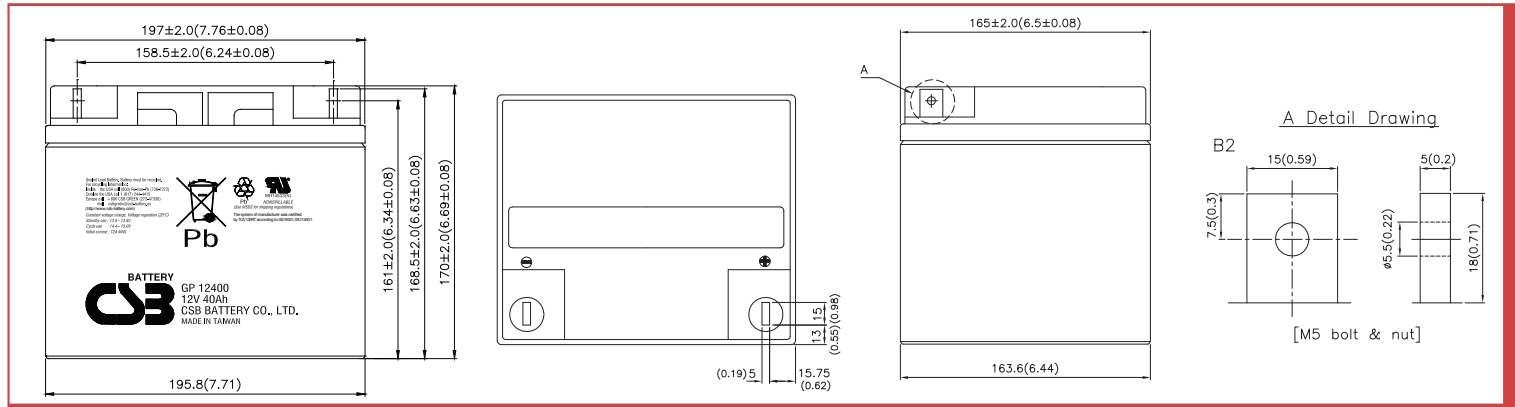

Constant Current Discharge Characteristics Unit:A (25°C,77°F)

F.V/Time	5MIN	10MIN	15MIN	30MIN	60MIN	90MIN	2HR	3HR	5HR	8HR	10HR	20HR
1.60V	176	113	85.0	51.8	30.6	22.2	17.7	12.6	8.01	5.25	4.28	2.21
1.67V	157	105	81.0	50.8	30.3	22.1	17.6	12.5	7.98	5.19	4.19	2.11
1.70V	149	101	78.7	50.1	30.2	21.9	17.5	12.4	7.96	5.17	4.16	2.08
1.75V	135	95.0	75.5	49.0	30.0	21.8	17.4	12.3	7.93	5.10	4.09	2.00
1.80V	121	88.3	71.7	47.6	29.8	21.7	17.3	12.2	7.88	5.03	4.03	1.93
1.85V	107	81.7	67.8	46.2	29.4	21.5	17.2	12.1	7.85	4.96	3.96	1.85

Constant Power Discharge Characteristics Unit:W(25°,77°F)

F.V/Time	5MIN	10MIN	15MIN	30MIN	60MIN	90MIN	2HR	3HR	5HR	8HR	10HR	20HR
1.60V	2110	1350	1020	622	367	266	212	151	96.1	63.0	51.3	26.5
1.67V	1886	1259	972	606	364	264	211	150	95.7	62.3	50.4	25.4
1.70V	1790	1214	945	600	363	263	210	149	95.5	62.0	50.0	24.9
1.75V	1620	1140	902	585	360	262	209	148	95.2	61.2	49.2	24.1
1.80V	1450	1060	860	571	357	260	208	147	94.8	60.4	48.3	23.2
1.85V	1280	980	814	555	353	258	207	146	94.2	59.6	47.5	22.4

Ratings presented herein are subject to revision without notice. Please refer to www.csb-battery.com to confirm the latest version.

Trickle (or Float) Service Life

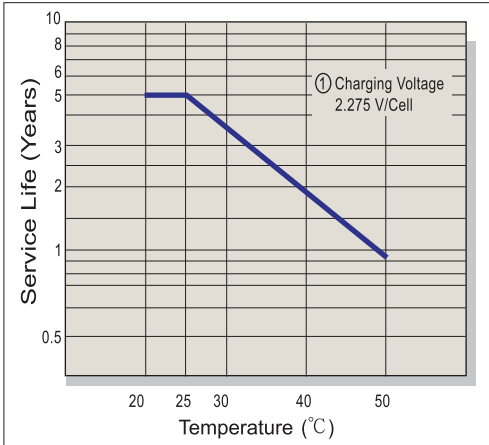

Capacity Retention Characteristic

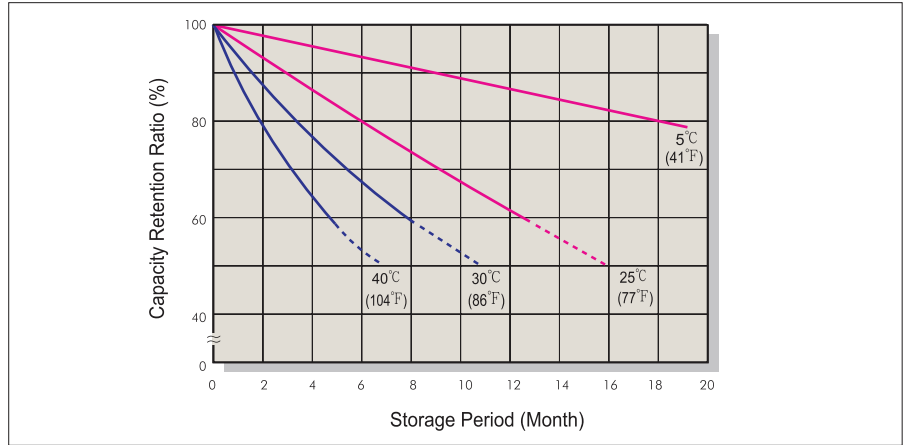

Battery Voltage and Charge Time for Standby Use

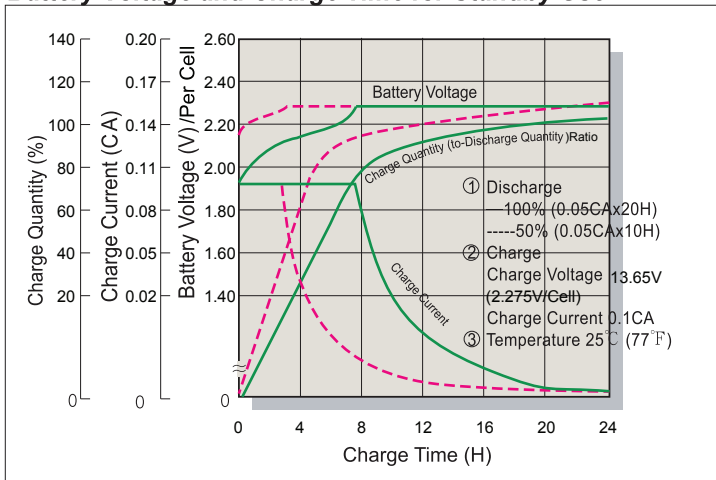

Cycle Service Life

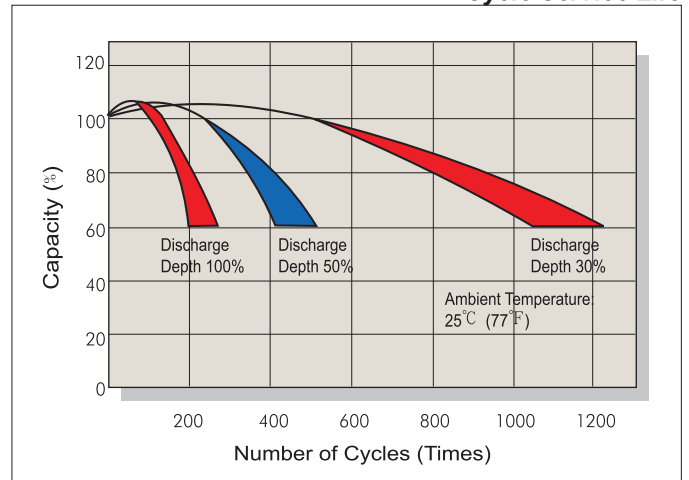

Battery Voltage and Charge Time for Cycle Use

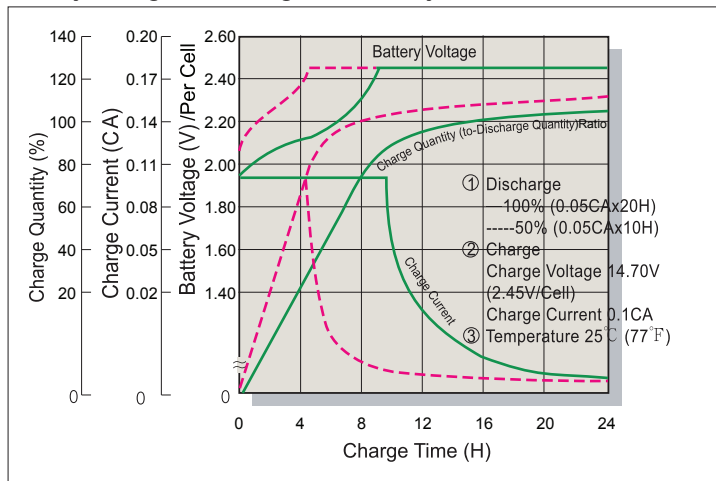

Terminal Voltage (V) and Discharge Time

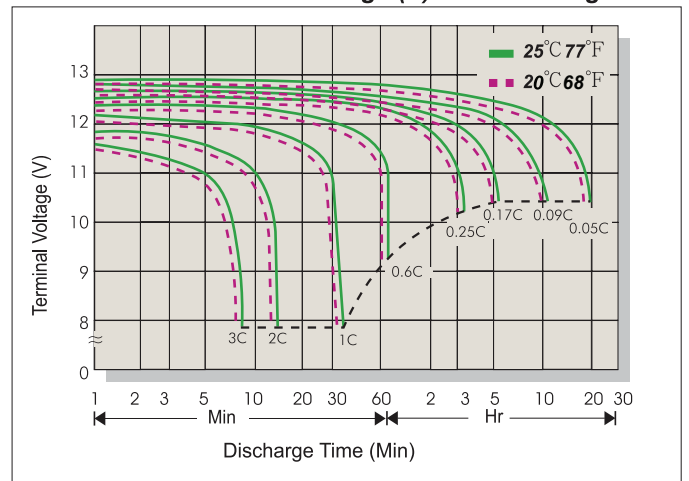

Charging Procedures

Application	Charge Voltage(V/Cell)			Max.Charge Current
	Temperature	Set Point	Allowable Range	
Cycle Use	25°C (77°F)	2.45	2.40~2.50	0.3C
Standby	25°C (77°F)	2.275	2.25~2.30	

Discharge Current VS. Discharge Voltage

Final Discharge Voltage V/Cell	1.75	1.70	1.60	1.30
Discharge Current(A)	0.2C>(A)	0.2C<(A)<0.5C	0.5C<(A)<1.0C	(A)>1.0C

Sales Office URL: WWW.CSB-BATTERY.COM

GLOBAL HQ
CSB BATTERY CO., LTD. (TAIWAN)
 Tel : +886-2-2880-5600
 Fax : +886-2-2888-3300
 mail : service@csb-battery.com.tw

BEIJING OFFICE. (CHINA)
CSB BATTERY TECHNOLOGIES (BEIJING) CO., LTD.
 Tel : +86-10-5820-5336/5338
 Fax : +86-10-58203053
 mail : chinasl@csb-battery.com

AMERICA HQ
CSB BATTERY TECHNOLOGIES INC. (U.S.A)
 Tel : +1-817-244-7777/1-(800)3-CSB-USA(272872)
 Fax : +1-817-244-4445
 mail : csb@csb-battery.com

SHANGHAI OFFICE. (CHINA)
CSB BATTERY LOGISTIC (SHANGHAI) CO., LTD.
 Tel : +86-21-5046-1622/5046-0833
 Fax : +86-21-5064-1046
 mail : chinasl@csb-battery.com

EUROPE HQ
CSB Battery Europe BV.
 Tel : +31(0)-180-418-140
 Fax : +31(0)-180-418-327
 mail : eurosales@csb-battery.eu

SHENZHEN OFFICE. (CHINA)
CSB BATTERY LOGISTIC (SHANGHAI) CO., LTD.
 Tel : +86-755-8831-6488/6396/6356
 Fax : +86-755-8831-6548
 mail : she@csb-battery.com.cn